

# Дюбели рамкови,к-кт с болт патентен

## FUR 8 x 120 SS K NV, блистер

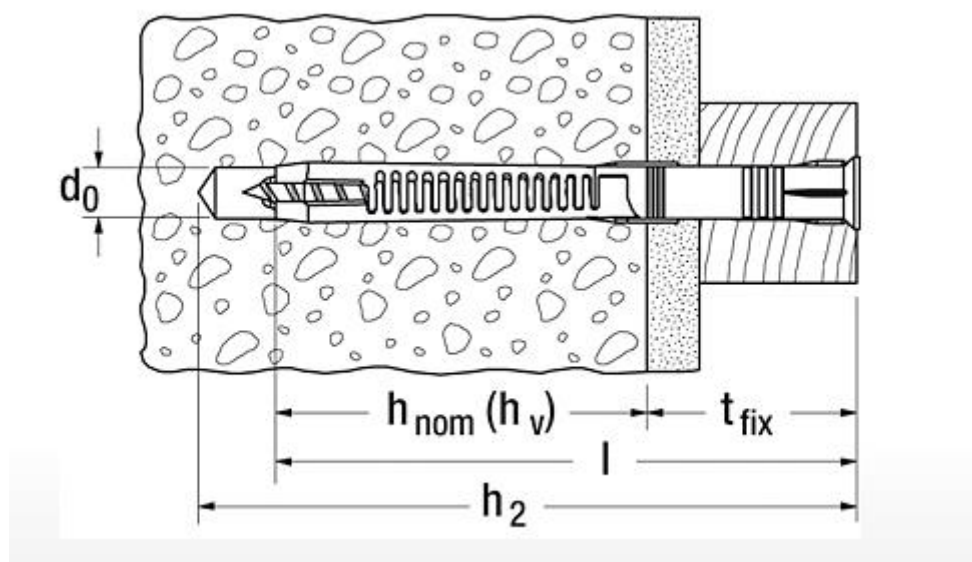

Drill hole diameter	$d_0$	8	[mm]
Anchor length	$l$	120	[mm]
Min. drill hole depth	$h_1$	130	[mm]
Min. drill hole depth for through fixings	$h_2$	130	[mm]
Min. anchorage depth	$h_{nom} (h_v)$	70	[mm]
Max. fixture thickness	$t_{fix}$	50	[mm]
Drive		SW10	
fischer safety screw	$d_s \times l_s$	6 x 125	[mm]
Card contents		4 x FUR 8 x 120 SS, 4 x safety screw 6 x 125 SW10	
Sales unit		10	[pcs]
GTIN (EAN Code)		4006209909409	